

Features

- 3.0W Power Dissipation
- Ideally Suited for Automated Assembly
- 3.3V - 200V Nominal Zener Voltage Range
- Standard V_Z Tolerance is $\pm 5\%$
- ESD Rating of Class 3 (>16kV) per Human Body Model
- **Lead-Free Finish; RoHS Compliant (Notes 1 & 2)**
- **Halogen and Antimony Free. "Green" Device (Note 3)**

Mechanical Data

- Case: SMB
- Case Material: Molded Plastic. UL Flammability Classification Rating 94V-0
- Moisture Sensitivity: Level 1 per J-STD-020
- Copper Alloy Leadframe with Lead-Free Plating (Matte Tin Finish). Solderable per MIL-STD-202, Method 208 
- Polarity: Cathode Band
- Weight: 0.096 grams (Approximate)

SMB

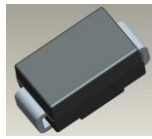

Top View

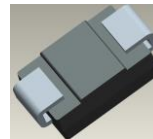

Bottom View

Ordering Information (Note 4)

Device*	Packaging	Shipping
1SMB59xxB-13	SMB	3,000/Tape & Reel

*x = Device Voltage, e.g., 1SMB5920B-13.

- Notes:
1. EU Directive 2002/95/EC (RoHS) & 2011/65/EU (RoHS 2) compliant. All applicable RoHS exemptions applied.
 2. See http://www.diodes.com/quality/lead_free.html for more information about Diodes Incorporated's definitions of Halogen- and Antimony-free, "Green" and Lead-free.
 3. Halogen- and Antimony-free "Green" products are defined as those which contain <900ppm bromine, <900ppm chlorine (<1500ppm total Br + Cl) and <1000ppm antimony compounds.
 4. For packaging details, go to our website at <http://www.diodes.com/products/packages.html>.

Marking Information

SMB

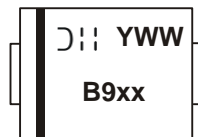

B9xx = Product Type Marking Code
(See Electric Characteristics Table)
YWW = Manufacturers' Code Marking
YWW = Date Code Marking
Y = Last Digit of Year (ex: 4 for 2014)
WW = Week Code (01 - 53)

Maximum Ratings (@T_A = +25°C, unless otherwise specified.)

Characteristic	Symbol	Value	Unit
Forward Voltage @ I _F = 200mA	V _F	1.5	V
Zener Current (See Page 3)	I _{ZM}	P _D / V _Z	mA

Thermal Characteristics

Characteristic	Symbol	Value	Unit
Power Dissipation @T _L = +75°C	P _D	3.0	W
Derate Above +75°C (Note 5)		40	mW/°C
Thermal Resistance - Junction to Terminal (Note 5)	R _{θJT}	25	°C/W
Power Dissipation @T _A = +25°C	P _D	550	mW
Derate Above +25°C (Note 5)		4.4	mW/°C
Thermal Resistance - Junction to Ambient (Note 5)	R _{θJA}	226	°C/W
Operating and Storage Temperature Range	T _J , T _{STG}	-65 to +150	°C

Note: 5. Device mounted on FR-4 PCB; pad layout as shown on Diodes Inc. suggested pad layout document AP02001, which can be found on our website at <http://www.diodes.com>.

Electrical Characteristics (@T_A = +25°C, unless otherwise specified.)

Type Number	Marking Code	Zener Voltage Range (Note 6)			Test Current	Maximum Zener Impedance (Note 7)			Maximum Reverse Current (Note 6)		I _{ZM} Max
		V _Z @ I _{ZT}				I _{ZT}	Z _{ZT} @ I _{ZT}	Z _{ZK} @ I _{ZK}		I _R @ V _R	
		Min (V)	Typ (V)	Max (V)	mA	Ω	Ω	mA	μA	V	
1SMB5913B	B913	3.13	3.3	3.47	113.6	10	500	1	100	1	454
1SMB5914B	B914	3.42	3.6	3.78	104.2	9	500	1	75	1	416
1SMB5915B	B915	3.7	3.9	4.1	96.1	7.5	500	1	25	1	384
1SMB5916B	B916	4.08	4.3	4.52	87.2	6	500	1	5	1	348
1SMB5917B	B917	4.46	4.7	4.94	79.8	5	500	1	5	1.5	319
1SMB5920B	B920	5.89	6.2	6.51	60.5	2	200	1	5	4	241
1SMB5921B	B921	6.46	6.8	7.14	55.1	2.5	200	1	5	5.2	220
1SMB5922B	B922	7.12	7.5	7.88	50	3	400	0.5	5	6	200
1SMB5923B	B923	7.79	8.2	8.61	45.7	3.5	400	0.5	5	6.5	182
1SMB5924B	B924	8.64	9.1	9.56	41.2	4	500	0.5	5	7	164
1SMB5925B	B925	9.5	10	10.5	37.5	4.5	500	0.25	5	8	150
1SMB5926B	B926	10.45	11	11.55	34.1	5.5	550	0.25	1	8.4	136
1SMB5927B	B927	11.4	12	12.6	31.2	6.5	550	0.25	1	9.1	125
1SMB5928B	B928	12.35	13	13.65	28.8	7	550	0.25	1	9.9	115
1SMB5929B	B929	14.25	15	15.75	25	9	600	0.25	1	11.4	100
1SMB5930B	B930	15.2	16	16.8	23.4	10	600	0.25	1	12.2	93
1SMB5931B	B931	17.1	18	18.9	20.8	12	650	0.25	1	13.7	83
1SMB5932B	B932	19	20	21	18.7	14	650	0.25	1	15.2	75
1SMB5933B	B933	20.9	22	23.1	17	17.5	650	0.25	1	16.7	68
1SMB5934B	B934	22.8	24	25.2	15.6	19	700	0.25	1	18.2	62
1SMB5935B	B935	25.65	27	28.35	13.9	23	700	0.25	1	20.6	55
1SMB5936B	B936	28.5	30	31.5	12.5	28	750	0.25	1	22.8	50
1SMB5937B	B937	31.35	33	34.65	11.4	33	800	0.25	1	25.1	45
1SMB5938B	B938	34.2	36	37.8	10.4	38	850	0.25	1	27.4	41
1SMB5939B	B939	37.05	39	40.95	9.6	45	900	0.25	1	29.7	38
1SMB5940B	B940	40.85	43	45.15	8.7	53	950	0.25	1	32.7	34
1SMB5941B	B941	44.65	47	49.35	8	67	1000	0.25	1	35.8	31
1SMB5942B	B942	48.45	51	53.55	7.3	70	1100	0.25	1	38.8	29
1SMB5943B	B943	53.2	56	58.8	6.7	86	1300	0.25	1	42.6	26
1SMB5944B	B944	58.9	62	65.1	6	100	1500	0.25	1	47.1	24
1SMB5945B	B945	64.6	68	71.4	5.5	120	1700	0.25	1	51.7	22
1SMB5946B	B946	71.25	75	78.75	5	140	2000	0.25	1	56	20
1SMB5947B	B947	77.9	82	86.1	4.6	160	2500	0.25	1	62.2	18
1SMB5948B	B948	86.45	91	95.55	4.1	200	3000	0.25	1	69.2	16
1SMB5949B	B949	95	100	105	3.7	250	3100	0.25	1	76	15
1SMB5950B	B950	104.5	110	115.5	3.4	300	4000	0.25	1	83.6	13
1SMB5951B	B951	114	120	128	3.1	380	4500	0.25	1	91.2	12
1SMB5952B	B952	123.5	130	136.5	2.9	450	5000	0.25	1	98.8	11
1SMB5953B	B953	142.5	150	157.5	2.5	600	6000	0.25	1	114	10
1SMB5954B	B954	152	160	168	2.3	700	6500	0.25	1	121.6	9
1SMB5955B	B955	171	180	189	2.1	900	7000	0.25	1	136.8	8
1SMB5956B	B956	190	200	210	1.9	1200	8000	0.25	1	152	7

Notes: 6. Short duration pulse test used to minimize self-heating effect.
7. ZENER IMPEDANCE (Z_Z) DERIVATION Z_{ZT} and Z_{ZK} are measured by dividing the AC voltage drop across the device by the AC current applied. The specified limits are for I_{Z(AC)} = 0.1 I_{Z(DC)} with the AC frequency = 60 Hz.

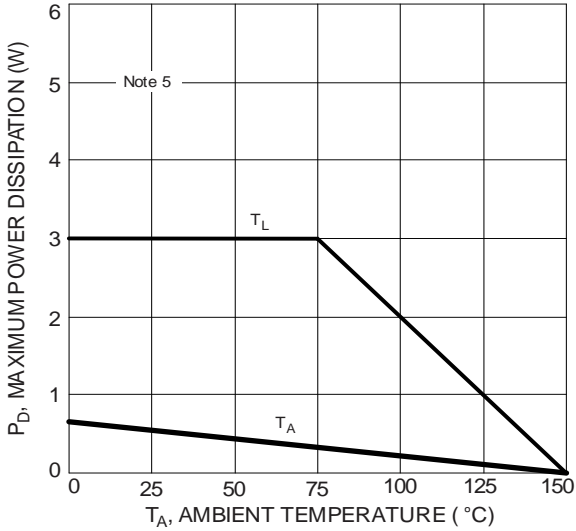

Figure Power Dissipation vs. Ambient Temperature

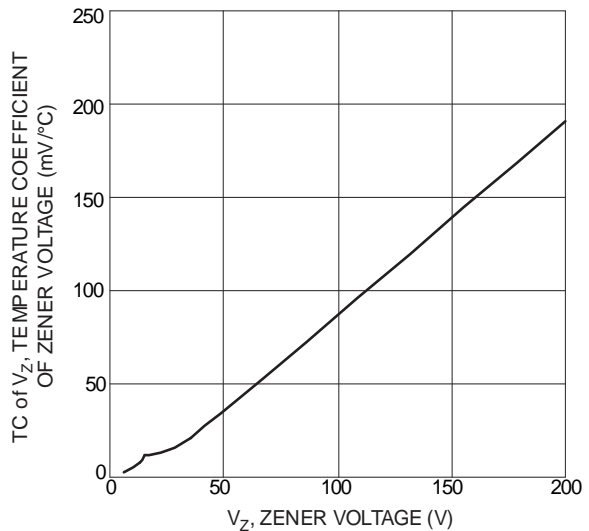

Figure 2 Typical Temperature Coefficient of Zener Voltage vs. Zener Voltage

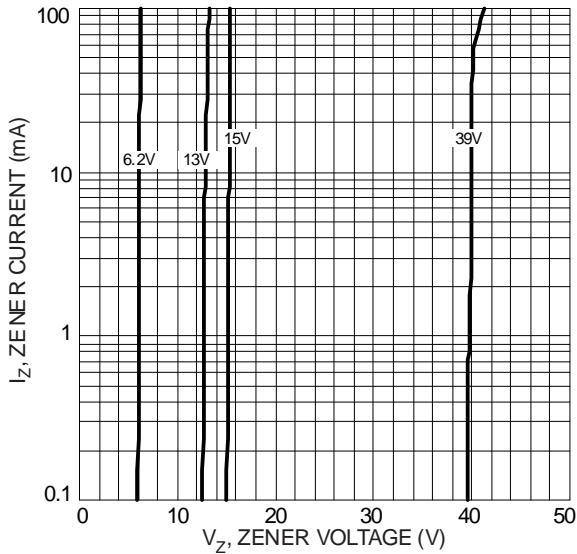

Figure 3 Typical Zener Breakdown Characteristics

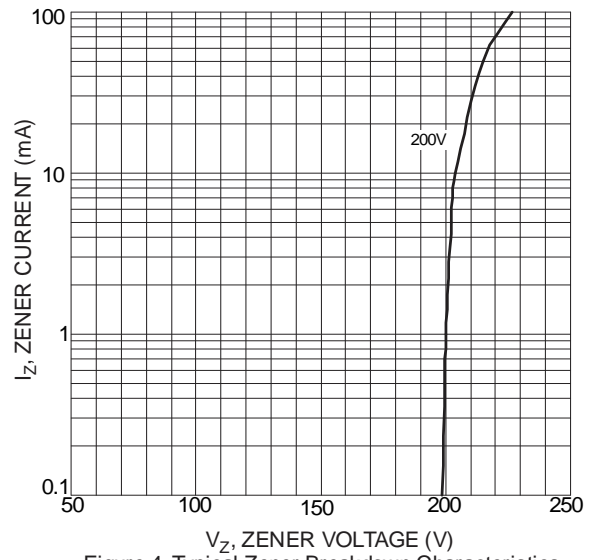

Figure 4 Typical Zener Breakdown Characteristics

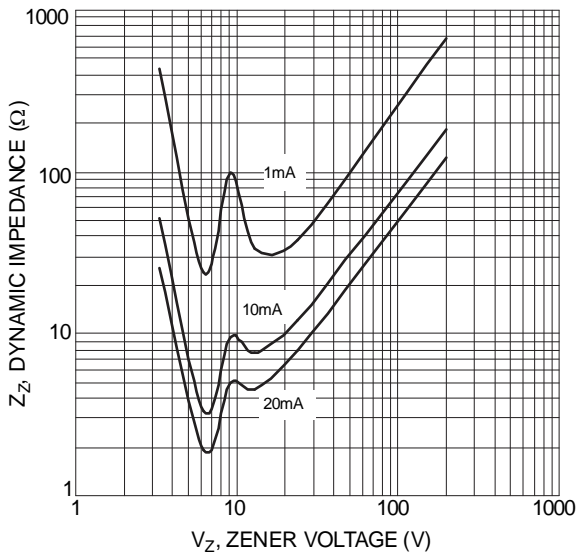

Figure 5 Effect of Zener Voltage

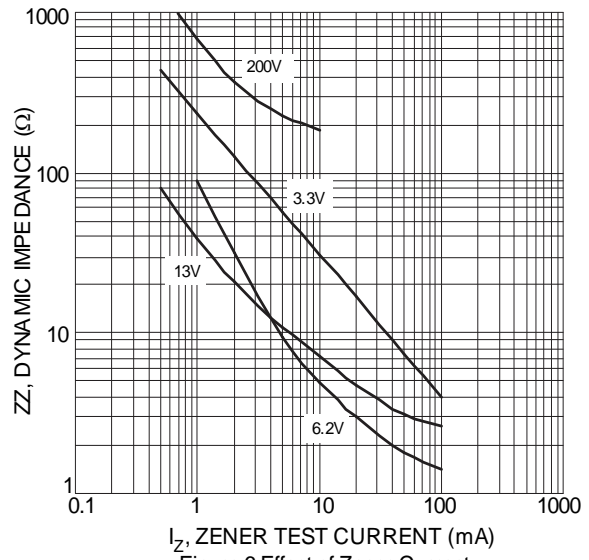

Figure 6 Effect of Zener Current

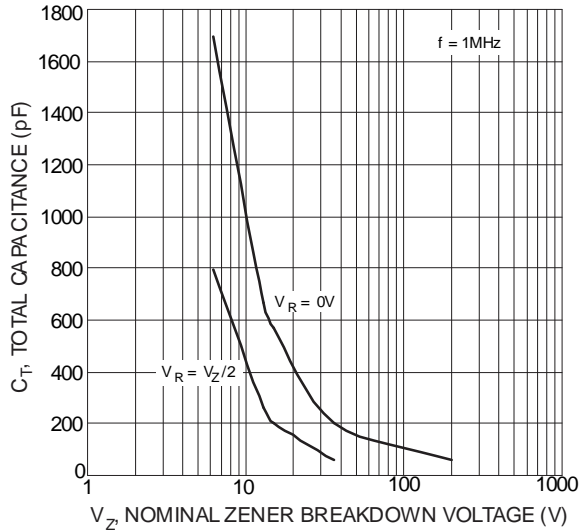

Figure 7 Typical Total Capacitance vs. Nominal Zener Breakdown Voltage

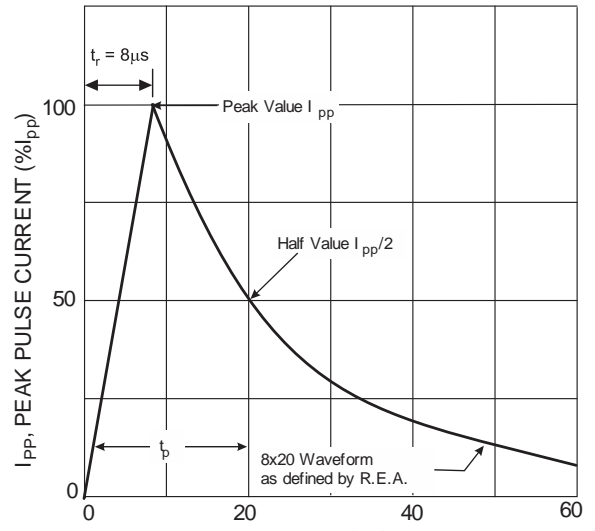

Figure 8 Pulse Waveform

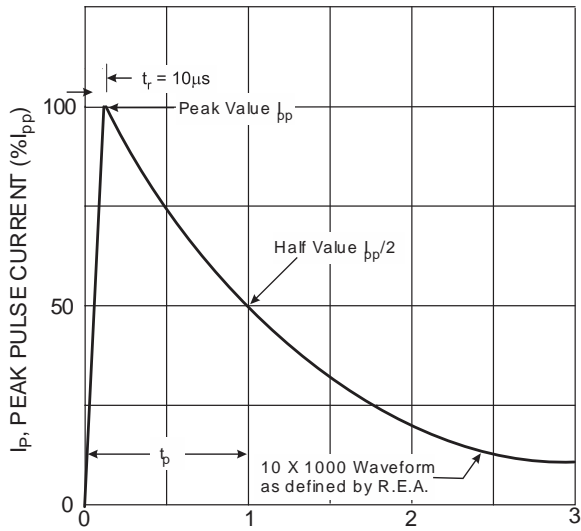

Figure 9 Pulse Waveform

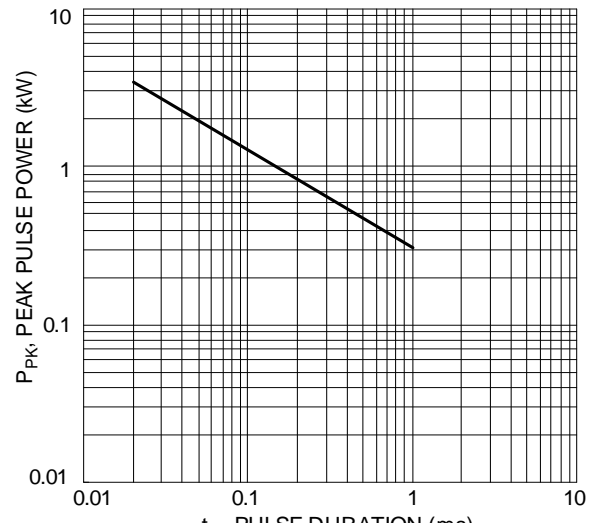
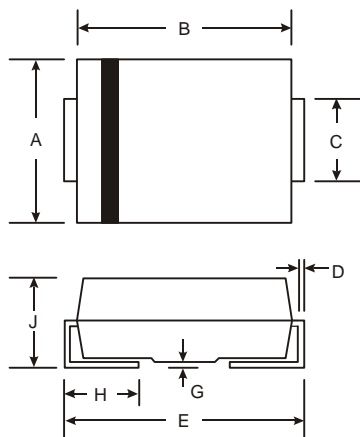

Figure 10 Max. Peak Pulse Power vs. Pulse Duration

Package Outline Dimensions

Please see AP02002 at <http://www.diodes.com/datasheets/ap02002.pdf> for the latest version.



SMB		
Dim	Min	Max
A	3.30	3.94
B	4.06	4.57
C	1.96	2.21
D	0.15	0.31
E	5.00	5.59
G	0.05	0.20
H	0.76	1.52
J	2.00	2.50

All Dimensions in mm

Suggested Pad Layout

Please see AP02002 at <http://www.diodes.com/datasheets/ap02002.pdf> for the latest version.

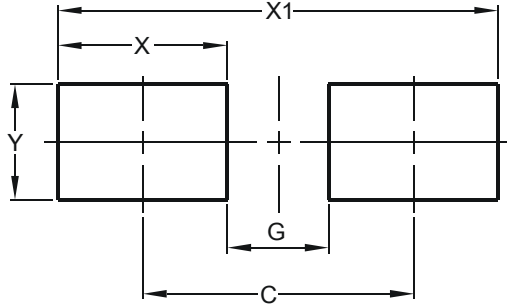

Dimensions	Value (in mm)
C	4.30
G	1.80
X	2.50
X1	6.80
Y	2.30

IMPORTANT NOTICE

DIODES INCORPORATED MAKES NO WARRANTY OF ANY KIND, EXPRESS OR IMPLIED, WITH REGARDS TO THIS DOCUMENT, INCLUDING, BUT NOT LIMITED TO, THE IMPLIED WARRANTIES OF MERCHANTABILITY AND FITNESS FOR A PARTICULAR PURPOSE (AND THEIR EQUIVALENTS UNDER THE LAWS OF ANY JURISDICTION).

Diodes Incorporated and its subsidiaries reserve the right to make modifications, enhancements, improvements, corrections or other changes without further notice to this document and any product described herein. Diodes Incorporated does not assume any liability arising out of the application or use of this document or any product described herein; neither does Diodes Incorporated convey any license under its patent or trademark rights, nor the rights of others. Any Customer or user of this document or products described herein in such applications shall assume all risks of such use and will agree to hold Diodes Incorporated and all the companies whose products are represented on Diodes Incorporated website, harmless against all damages.

Diodes Incorporated does not warrant or accept any liability whatsoever in respect of any products purchased through unauthorized sales channel. Should Customers purchase or use Diodes Incorporated products for any unintended or unauthorized application, Customers shall indemnify and hold Diodes Incorporated and its representatives harmless against all claims, damages, expenses, and attorney fees arising out of, directly or indirectly, any claim of personal injury or death associated with such unintended or unauthorized application.

Products described herein may be covered by one or more United States, international or foreign patents pending. Product names and markings noted herein may also be covered by one or more United States, international or foreign trademarks.

This document is written in English but may be translated into multiple languages for reference. Only the English version of this document is the final and determinative format released by Diodes Incorporated.

LIFE SUPPORT

Diodes Incorporated products are specifically not authorized for use as critical components in life support devices or systems without the express written approval of the Chief Executive Officer of Diodes Incorporated. As used herein:

A. Life support devices or systems are devices or systems which:

1. are intended to implant into the body, or
2. support or sustain life and whose failure to perform when properly used in accordance with instructions for use provided in the labeling can be reasonably expected to result in significant injury to the user.

B. A critical component is any component in a life support device or system whose failure to perform can be reasonably expected to cause the failure of the life support device or to affect its safety or effectiveness.

Customers represent that they have all necessary expertise in the safety and regulatory ramifications of their life support devices or systems, and acknowledge and agree that they are solely responsible for all legal, regulatory and safety-related requirements concerning their products and any use of Diodes Incorporated products in such safety-critical, life support devices or systems, notwithstanding any devices- or systems-related information or support that may be provided by Diodes Incorporated. Further, Customers must fully indemnify Diodes Incorporated and its representatives against any damages arising out of the use of Diodes Incorporated products in such safety-critical, life support devices or systems.

Copyright © 2014, Diodes Incorporated

www.diodes.com